

SQFLAT LED 1.1

Advantages

- Quick and easy installation
- Low UGR coefficients

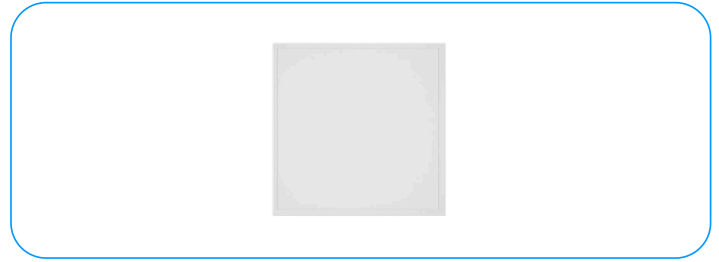

IP40



SQFLAT LED 1.11



P



Ra

IP



SQF1ST.11.021.8A3000

21

2500

3000K

>80

IP40

90°X90°

2,2kg

SQF1ST.11.021.8A4000

21

2650

4000K

>80

IP40

90°X90°

2,2kg

SQFLAT LED 1.12



P



Ra

IP



SQF1ST.21.025.8A3000

25

3000

3000K

>80

IP40

90°X90°

2,2kg

SQF1ST.21.025.8A4000

25

3150

4000K

>80

IP40

90°X90°

2,2kg

SQFLAT LED 1.13



P



Ra

IP



SQF1ST.31.029.8A3000

29

3500

3000K

>80

IP40

90°X90°

2,2kg

SQF1ST.31.029.8A4000

29

3650

4000K





>80

IP40





90°X90°

2,2kg





SQFLAT LED 1.1 4

	P			Ra	IP		
SQF1ST.41.034.8A3000	34	4000	3000K	>80	IP40	90°X90°	2,2kg
SQF1ST.41.034.8A4000	34	4200	4000K	>80	IP40	90°X90°	2,2kg

SQFLAT LED 1.1 5

	P			Ra	IP		
SQF1ST.51.038.8A3000	38	4500	3000K	>80	IP40	90°X90°	2,2kg
SQF1ST.51.038.8A4000	38	4700	4000K	>80	IP40	90°X90°	2,2kg

SQFLAT LED 1.1 6

	P			Ra	IP		
SQF1ST.61.044.8A3000	44	5200	3000K	>80	IP40	90°X90°	2,2kg
SQF1ST.61.044.8A4000	44	5450	4000K	>80	IP40	90°X90°	2,2kg

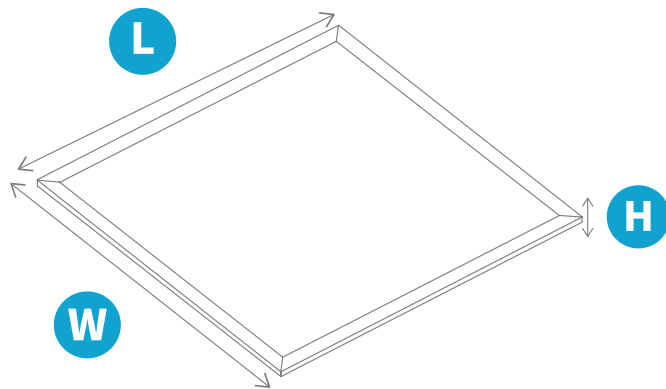

	H	W	L
---	---	---	---

SQF1ST.2	10	595	595
SQF1ST.3	10	595	595
SQF1ST.4	10	595	595
SQF1ST.5	10	595	595
SQF1ST.6	10	595	595
SQF1ST.1	10	595	595

			
---	---	---	---

SQF1ST.2	2,4	64	120x80
SQF1ST.3	2,4	64	120x80
SQF1ST.4	2,4	64	120x80
SQF1ST.5	2,4	64	120x80
SQF1ST.6	2,4	64	120x80
SQF1ST.1	2,4	64	120x80

Montage

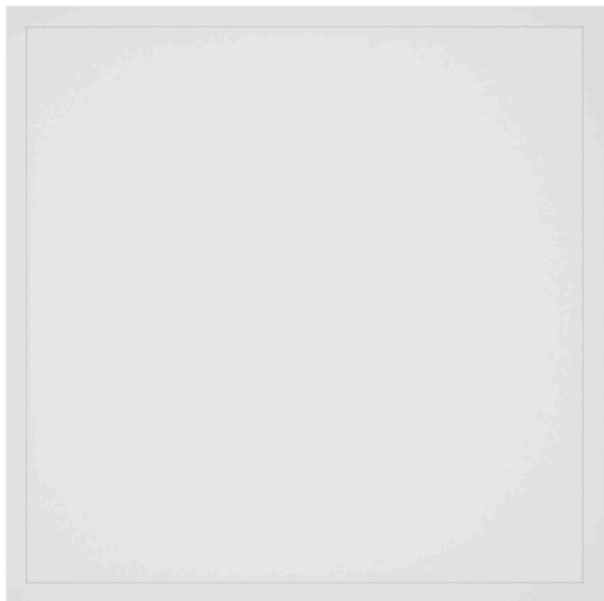

Surface mounting



Recessed-mounted

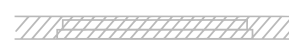

Modular ceiling



Suspended



Luminous flux

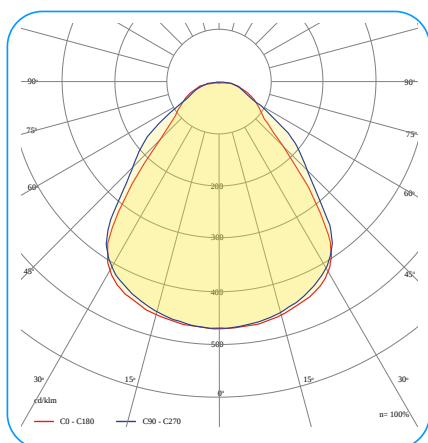

90°X90°

Available configurations

Family	Power version	Version	Power [W]	CRI	Type of diode	CCT [K]	Lens material	Diffuser material	Beam angle	Control	Operating temperature	Warranty	Modifications
SQF1ST SQFLAT LED 1,1	1 1	1 Lift 1	021 21W	8 >80	A Mid Power	3000 3000K	0 No lens	P34 PS diffuser Microprismatic	090090 90°x90°	00 On/Off	2040 -20°C:+40°C	05Y 5 Years	0000 No modification
	2 2		025 25W			4000 4000K				D0 DALI			
	3 3		029 29W										
	4 4		034 34W										
	5 5		038 38W										
	6 6		044 44W										

Example product code

SQF1ST.21.025.8A4000.OP34.090090.00.2040.05Y.0000