

SQLight LED MP 1.0

LUXON

INSTRUKCJA MONTAŻU

INSTALLATION INSTRUCTIONS

MONTAGEANLEITUNG

i

Źródło światła zastosowane w tej oprawie oświetleniowej powinno być wymieniane wyłącznie przez producenta lub jego przedstawiciela serwisowego, lub podobnie wykwalifikowaną osobę.

The light source used in this luminaire should be replaced only by the manufacturer or his service representative, or a similarly qualified person.

Die in dieser Leuchte verwendete Lichtquelle sollte nur vom Hersteller oder seinem Servicemitarbeiter oder einer ähnlich qualifizierten Person ausgetauscht werden.

L [mm] 595

W [mm] 595

H [mm] 35

Masa
Weight
Gewicht 1,8 kg

Ta stnd. [°C] 0C ÷ +40C

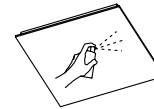
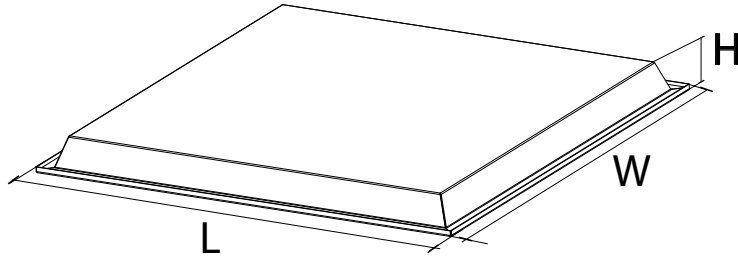

Sprężone Powietrze
Compressed air
Druckluft

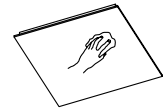

Miękka ściereczka
Soft cloth
Weiches Tuch

Firma Luxon zastrzega sobie prawo do wprowadzania zmian konstrukcyjnych.

Luxon reserves the right to make construction changes.

Luxon behält sich das Recht vor, Konstruktionsänderungen vorzunehmen.

1

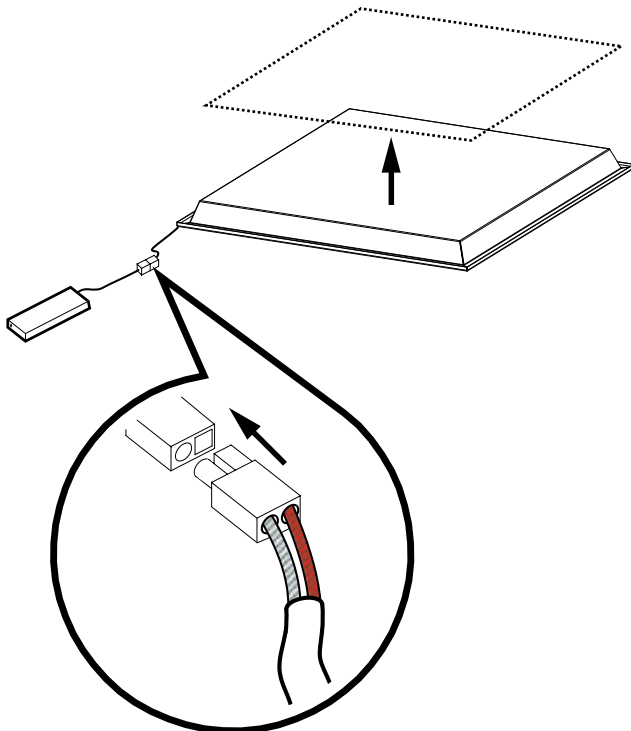

2

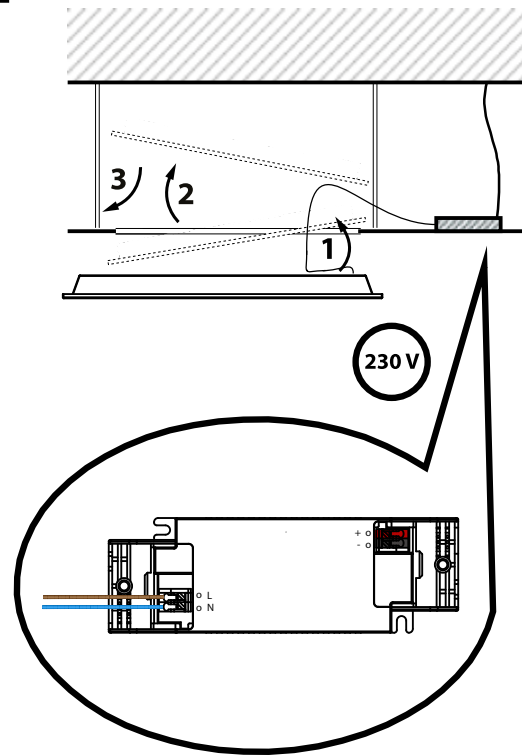

NIE ZAKRYWAĆ materiałem izolacyjnym!
DO NOT cover with insulating material!
Mit Isoliermaterial **NICHT** abdecken!

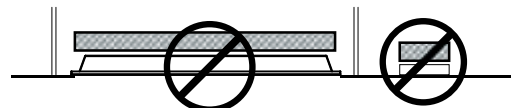

Yellow/Green Żółty/Zielony Gelb/Grün Blue/Niebieski/Blau Brown/Brazowy/Braun Grey/Szary/Grau Black/Czarny/Schwarz

IP40

50/60
Hz

230 V



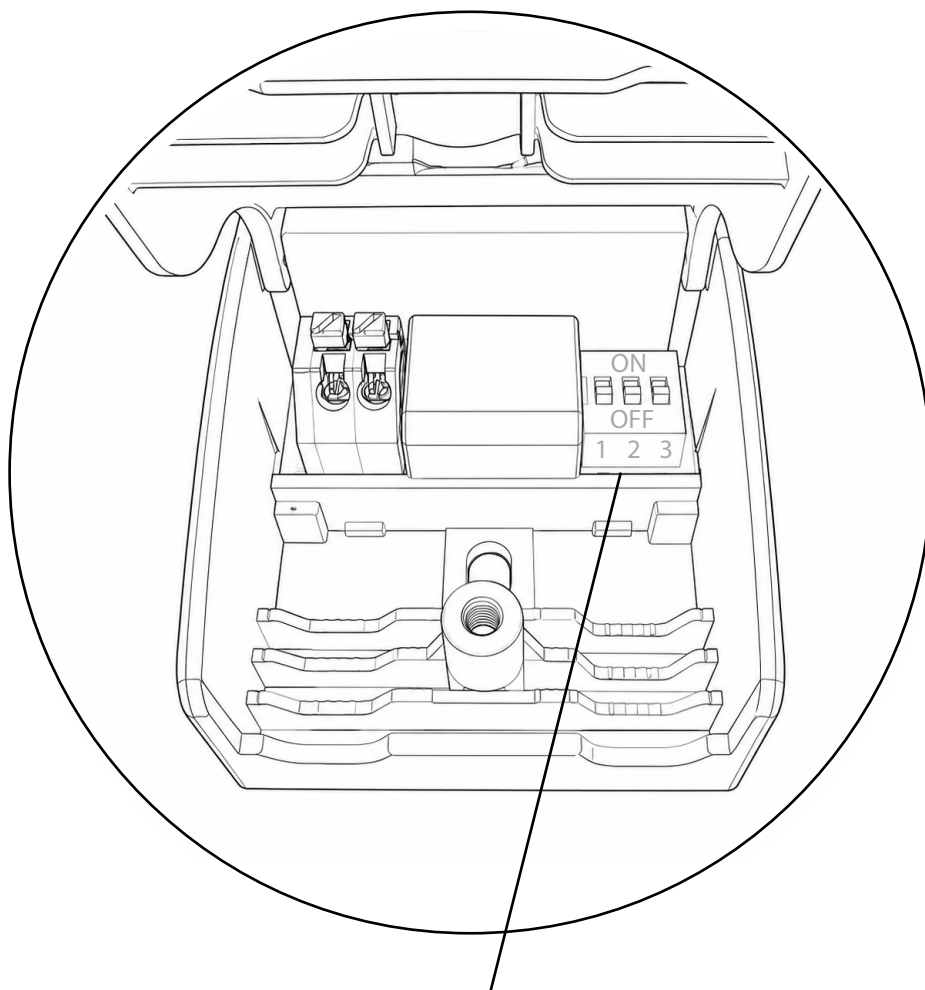

CE

i Wybór mocy na zasilaczu / power selection on the power supply / Leistungsauswahl am Netzteil



Pin 1	Pin 2	Pin 3	Current [mA]	Power [W]	Luminous flux [lm]
ON	OFF	OFF	400	19	3200
ON	ON	OFF	500	23	3950
ON	OFF	ON	600	28	4800
ON	ON	ON	700	32	5550

 Yellow/Green Żółty/Zielony Gelb/Grün
  Blue/Niebieski/Blau
  L1 Brown/Brazowy/Braun
  L2 Grey/Szary/Grau
  L3 Black/Czarny/Schwarz

IP40	50/60 Hz	230 V			CE
------	----------	-------	---	---	----